

CR 2200

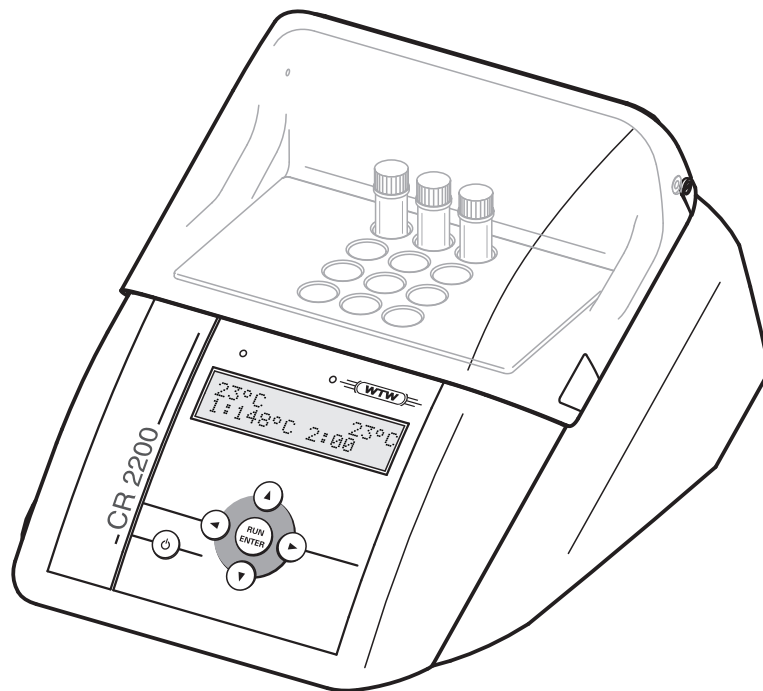

**Accuracy when going to
press**

The use of advanced technology and the high quality standard of our instruments are the result of continuous development. This may result in differences between this operating manual and your instrument. Also, we cannot guarantee that there are absolutely no errors in this manual. Therefore, we are sure you will understand that we cannot accept any legal claims resulting from the data, figures or descriptions.

Copyright

© Weilheim 2007, WTW
Reprinting - even as excerpts - is only allowed with the explicit written authorization of WTW GmbH, Weilheim.
Printed in Germany.

CR 2200 - Contents

1	Overview	37
1.1	Components of the thermoreactor	38
2	Safety	39
2.1	Authorized use	40
2.2	General safety instructions	40
3	Commissioning	43
3.1	Scope of delivery	43
3.2	Initial commissioning	44
4	Basic principles of operation	47
4.1	Operating and display elements	47
4.1.1	Keys	48
4.1.2	Display	49
4.1.3	Control lamps (LEDs)	49
4.2	Operating modes	50
5	Operation	51
5.1	Inserting the reaction cells	51
5.2	Starting a temperature program	51
5.3	Stopping a temperature program	53
5.4	Settings	54
5.4.1	Setting the display contrast	54
5.4.2	Setting the timer for the reaction time	54
6	Maintenance, cleaning, disposal	57
6.1	Maintenance	57
6.2	Exchanging the fuses	57
6.3	Cleaning the enclosure	58
6.4	Cleaning of the thermoblock of spilled cell contents ...	58
6.5	Disposal	58
7	What to do if...	59
8	Technical Data	61
9	Index	63

1 Overview

The thermoreactor CR 2200 is a dry temperature control device for laboratory use. It facilitates and secures the digestion using reaction cells.

The thermoreactor has 7 fixed temperature programs.

- 1: 148 °C for 120 minutes
- 2: 120 °C for 30 minutes
- 3: 120 °C for 60 minutes
- 4: 120 °C for 120 minutes
- 5: 100 °C for 60 minutes
- 6: 148 °C for 20 minutes
- 7: 150 °C for 120 minutes

The thermoreactor takes 12 reaction cells with an outer diameter of 16 mm.

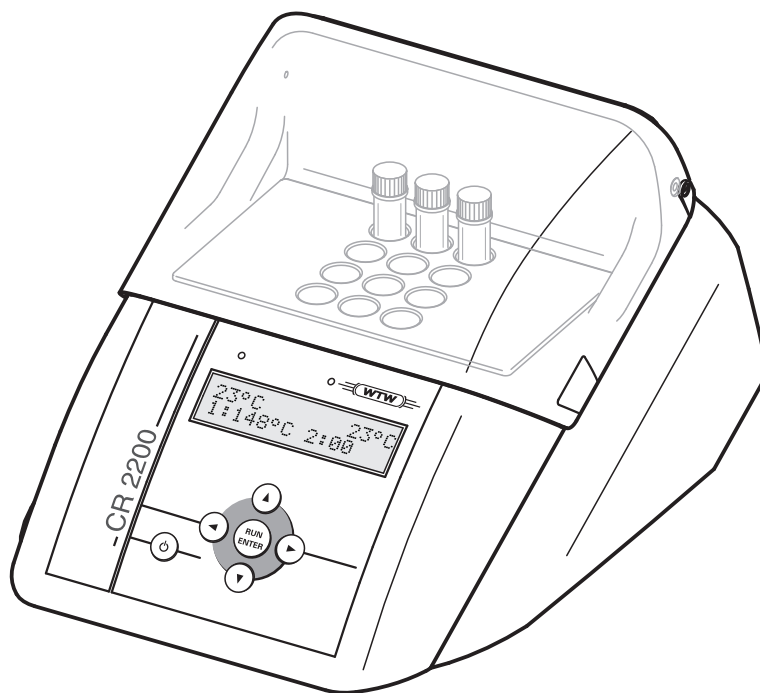

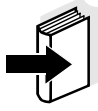
**Note**

You will find information on accessories in the WTW catalog LABORATORY AND FIELD INFORMATION or via the Internet.

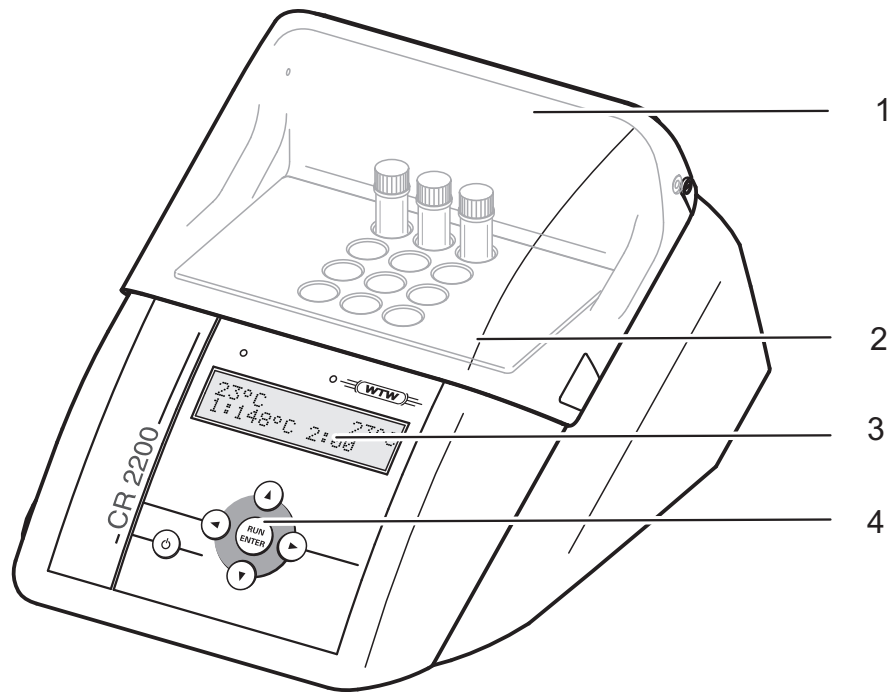
1.1 Components of the thermoreactor

1	Protection cover
2	Thermoblock with cell shafts
3	Display
4	Keypad

2 Safety

This operating manual contains basic instructions that you must follow during the commissioning, operation and maintenance of the thermoreactor. Consequently, all responsible personnel must read this operating manual before working with the thermoreactor. The operating manual must always be available within the vicinity of the thermoreactor.

Target group

The thermoreactor was developed for use in the laboratory. Thus, we assume that, as a result of their professional training and experience, the operators will know the necessary safety precautions to take when handling chemicals.

General safety instructions

The individual chapters of this operating manual use the following safety labels to indicate different levels of danger:



Warning

indicates instructions that must be followed precisely in order to prevent serious dangers to persons.



Caution

indicates instructions that must be followed precisely in order to avoid slight injuries or damage to the instrument or the environment.

Other labels



Note

indicates notes that draw your attention to special features.



Note

indicates cross-references to other documents, e.g. application reports.

2.1 Authorized use

The authorized use of the thermoreactor is exclusively the heating of samples in cells in a laboratory. The technical specifications as given in chapter 8 TECHNICAL DATA must be observed. Only the operation and running of the measuring instrument according to the instructions given in this operating manual is authorized. Any other use is considered **unauthorized**.

2.2 General safety instructions

This thermoreactor is constructed and tested in compliance with the EN 61010 safety regulations for electronic measuring instruments. It left the factory in a safe and secure technical condition.

Function and operating safety

The smooth functioning and operational safety of the thermoreactor can only be guaranteed if the generally applicable safety measures and the specific safety instructions in this operating manual are followed during operation.

The smooth functioning and operational safety of the thermoreactor can only be guaranteed under the environmental and electrical operating conditions that are specified in chapter 8 TECHNICAL DATA.

If the thermoreactor was transported from a cold environment to a warm environment, the formation of condensate can impair the functioning of the measuring system. In this event, wait until the temperature of the thermoreactor reaches room temperature before putting the thermoreactor back into operation.



Caution

The thermoreactor is only allowed to be opened by personnel authorized by WTW.

Safe operation

If safe operation is no longer possible, the thermoreactor must be taken out of service and secured against inadvertent operation. Safe operation is no longer possible if the thermoreactor

- has been damaged in transport
- has been stored under adverse conditions for a lengthy period of time
- is visibly damaged
- no longer operates as described in this manual.

If you are in any doubt, please contact the supplier of the thermoreactor.

Obligations of the purchaser

The purchaser of this thermoreactor must ensure that the following laws and guidelines are observed when using dangerous substances:

- EEC directives for protective labor legislation
- National protective labor legislation
- Safety regulations
- Safety datasheets of the chemical manufacturers.

3 Commissioning

3.1 Scope of delivery

- Thermoreactor CR 2200
- Connection cable for mains connection
- Operating manual



Warning

Always keep the original packing including the inner packing. If you have to transport the instrument, the packing protects the instrument optimally from hard shocks.

The original packing is also required for the appropriate return transport of the instrument if it has to be repaired.

Please note that the warranty does not cover damage caused by inappropriate transport.

3.2 Initial commissioning



Note

The thermoreactor works at an ambient temperature of +5 °C to +40 °C. When the thermoreactor was transported from a cold environment to a warm environment, condensate may occur and cause a malfunction. Wait until the thermoreactor has adjusted to the new environmental conditions before putting it into operation again (see also chapter 8 TECHNICAL DATA).

Setting up the thermoreactor

1	Place the thermoreactor firmly onto a heat-resistant underground.
2	Make sure that there is enough space between the thermoreactor and other instruments or devices that are heat-sensitive.

Adjusting the mains voltage

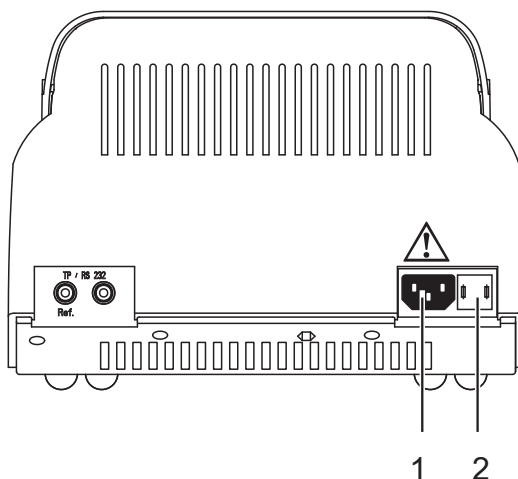

3	Check whether the arrow on the housing points to the mains voltage (115 or 230 V) given on the fuse holder (2) that is provided by the mains.
4	If the wrong mains voltage is set, perform steps 5 to 7.
5	Pull out the fuse holder (2).
6	Turn the fuse holder (2) so that the arrow on the housing points to the mains voltage (115 or 230 V) provided by the mains.
7	Push the fuse holder (2) in completely.

Connecting the mains cable

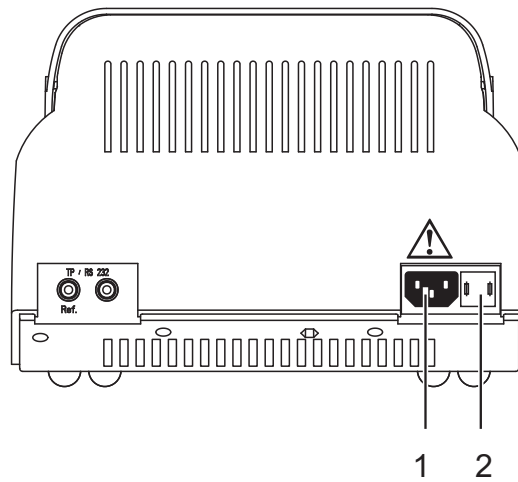

- | | |
|----------|-----------------------|
| 1 | Socket for mains plug |
| 2 | Fuse holder |

- | | |
|----------|--|
| 8 | Connect the mains cable to the socket 1 on the thermoreactor. |
| 9 | Connect the mains cable to an easily available mains socket.
The thermoreactor is now in the Standby mode.
The display shows the name of the instrument. |

CR 2200 U X.XX

The thermoreactor is ready for operation.

4 Basic principles of operation

This chapter provides you with basic information on how to operate the thermoreactor.

4.1 Operating and display elements

Using the six keys of the keypad (see section 4.1.1) you control the thermoreactor.

Temperature values, available temperature programs or settings can be viewed in the display (see section 4.1.2).

The control lamps above the operating panel are assigned to the thermoblock. Their color (red or green) and their state (flashing or illuminated) show the current operating state of the thermoreactor (see section 4.1.3).

4.1.1 Keys

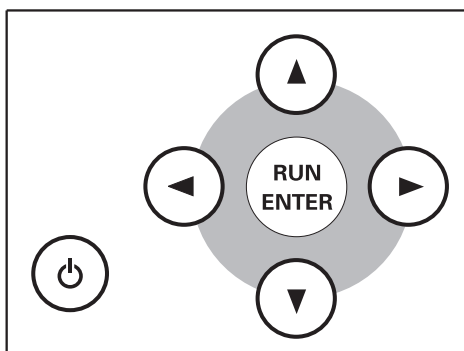

Key	Meaning
	On/off switch
	<ul style="list-style-type: none"> ● Making or confirming a selection or <ul style="list-style-type: none"> ● Starting the timer for the reaction time (active temperature program).
	Keep depressed and simultaneously press : Changing to the <i>SETUP</i> menu from the Standby mode
	<ul style="list-style-type: none"> ● Changing between the temperature setting and the reaction time setting (in the <i>SETUP</i> menu) or <ul style="list-style-type: none"> ● Canceling the active temperature program
	<ul style="list-style-type: none"> ● Selecting the temperature program (program selection) or <ul style="list-style-type: none"> ● Changing settings and switching between settings (<i>SETUP</i>) ● Starting the scrolling through settings by keeping the key depressed

4.1.2 Display

Example: Program selection

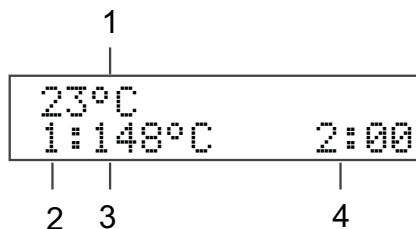

1	Temperature in the thermoblock
2	Number of the temperature program
3	Specified temperature
4	Reaction time in hours and minutes

4.1.3 Control lamps (LEDs)



The control lamps above the operating panel are assigned to the thermoblock and indicate the current operating state.

LED	flashes	is illuminated
green		Program selection
red	active temperature program: heating period or cooling period	active temperature program: reaction temperature reached
red and green	active temperature program: program canceling selected	

If the control lamps are off the thermoreactor is in the Standby mode.

4.2 Operating modes

The thermoreactor has three operating modes:

- Standby
The display shows the model and version number of the thermoreactor.
Using the  and  keys simultaneously takes you to the *SETUP* menu. There you can:
 - Set the display contrast (*CONTRAST:0* to *9*, see section 5.4.1)
 - Activate a manual confirmation before the timer for the reaction time is started (*START TIMER:MAN.* or *AUTO*, see section 5.4.2)
- Program selection
After switching on with  the display shows the current temperature value for the thermoblock. The second display line shows the temperature programs to be selected. The control lamps above the display light up green.
- Active temperature program
The display shows the current temperature value for the thermoblock. The control lamps above the display light up or flash red.

5 Operation

5.1 Inserting the reaction cells

The reaction cells can either be inserted at room temperature or when the thermoreactor has been preheated.



Caution

When dealing with chemicals always follow the safety data sheets and the regulations for prevention of accidents.



Caution

Observe the analysis specifications of the test sets used.



Warning

The thermoblock can become very hot (150 °C).
There is danger of burning when the thermoblock is heated up.



Note



When cold reaction cells are inserted in the preheated thermoblock it can cool down by approx. 3 °C.

- | | |
|---|--|
| 1 | Insert the filled reaction cells in the cell shafts. |
| 2 | Close the protection cover. |

5.2 Starting a temperature program

- | | |
|---|--|
| 1 | Switch the thermoreactor on with  . |
|---|--|

23°C 1:148°C 2:00

- | | |
|--|---|
| 2 | Select a temperature program with   . |
| You can select from 7 predefined temperature programs. | |

23°C 4:120°C 2:00	23°C
----------------------	------

- 3 Start the displayed temperature program with .
The control lamp for the thermoblock flashes red.
The nominal reaction time (in hours and minutes) appears on the display.

**Note**

The reaction temperature is reached when the temperature in the thermoblock is in a range of ± 1 °C around the adjusted temperature for two minutes constantly. The control lamps of the thermoblock will then light up red.

**Note**

If the start of the timer for the reaction time has been set to automatic in the *SETUP* menu (*START TIMER:AUTO* see Abschnitt 5.4.2), the reaction time automatically starts after the reaction temperature has been achieved. The reaction temperature is kept constant during the reaction time.



54°C
2:00

**Note**

If the start of the timer for the reaction time has been set to manual in the *SETUP* menu (*START TIMER:MAN.* see Abschnitt 5.4.2), an *S* is displayed in front of the nominal reaction time. With this setting the thermoreactor controls the temperature until the timer for the reaction time is started by pressing .



100°C
S2:00

- 4 If an *S* appears in front of the reaction time:
Start the timer for the reaction time with . The *S* in front of the reaction time disappears.

The reaction temperature is kept constant during the reaction time. The control lamps of the thermoblock will then light up red.

After the reaction time has expired the control lamps flash red and an acoustic signal is heard.

- 5 Using  confirm the end of the reaction time for each thermoblock.
The temperature program and the acoustic signal are finished.
The thermoreactor is in the program selection mode.

5.3 Stopping a temperature program

You can terminate a running program at any time.

- 1 Using ◀ ▶, terminate the running temperature program. The control lamp for the thermoblock flashes red/green. The safety query *STOP?* is displayed.

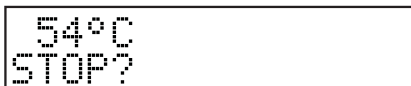

54°C
STOP?

- 2 Using  confirm the safety query *STOP?*. The temperature program is finished. The control lamps of the thermoblock will then light up green. or: Using ◀ ▶, leave *STOP?*. The query *STOP?* disappears from the display. The temperature program is continued.







Note

While *STOP?* is displayed the temperature program goes on running. As soon as a section of the temperature program is finished (e.g. after the end of the heating period or after the end of the reaction time), the *STOP?* display is overwritten.

5.4 Settings

5.4.1 Setting the display contrast

The display contrast can be set in 10 steps.

1	Switch to the Standby mode.
2	Keep the  key depressed while you press  to switch to the <i>SETUP</i> menu. <i>SETUP</i> and, in the second line, an editable parameter are displayed.
3	Using   select <i>CONTRAST</i> .





```

SETUP
CONTRAST:5
  
```

4	Using  edit the contrast setting. The editing is marked on the display by*.
---	---

```

SETUP      *
CONTRAST:5
  
```





5	Using   set the contrast from 0 to 9.
6	Using  confirm the changes. The marking on the display (*) disappears.
7	Using  leave the <i>SETUP</i> menu. The changes are stored. The thermoreactor is switched on (operation mode: program selection).

5.4.2 Setting the timer for the reaction time

After the start of a temperature program the thermoblock starts heating up. Depending on the setting, the timer for the reaction time starts automatically after the reaction temperature has been reached or only after confirmation by keypressing.

With the setting *START TIMER:AUTO* the timer for the reaction time starts immediately after the reaction temperature has been reached.





With the setting *START TIMER:MAN*, the timer for the reaction time starts after confirmation by keypressing only.

1	Switch to the Standby mode.
2	Keep the  key depressed while you press  to switch to the <i>SETUP</i> menu. <i>SETUP</i> and, in the second line, an editable parameter or a temperature program are displayed.
3	Using   select <i>START TIMER</i> .

```

SETUP
START TIMER:MAN.

```

4	Using  set the start of the timer for the reaction time. The editing is marked on the display by *.
5	Using   select <i>MAN.</i> or <i>AUTO</i> .
6	Using  confirm the changes. The marking on the display (*) disappears.
7	Using  leave the <i>SETUP</i> menu. The changes are stored. The thermoreactor is switched on (operation mode: program selection).

6 Maintenance, cleaning, disposal

6.1 Maintenance

The CR 2200 thermoreactor is maintenance-free.

6.2 Exchanging the fuses

- 1 Disconnect the line power cable from the thermoreactor.

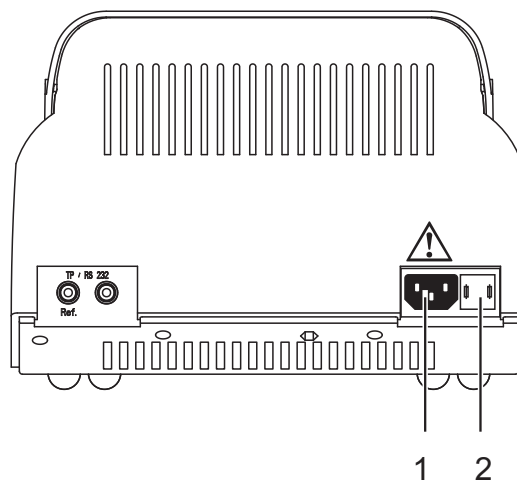

- 2 Pull out the fuse holder (2).
- 3 Exchange one or both fuses (3.15 AT).
- 4 Turn the fusion holder (2) so that the arrow on the housing points to the line voltage (115 or 230 V) provided by the power line.
- 5 Push the fusion holder (2) completely in.

6.3 Cleaning the enclosure

Wipe the thermoreactor with a damp cloth.



Caution

The housing is made of synthetic material. Thus, avoid contact with acetone or detergents that contain solvents. Remove any splashes immediately.

6.4 Cleaning of the thermoblock of spilled cell contents

If liquid penetrated a thermoblock (e.g. from a cell), clean the thermoblock as follows:



Warning

Cells can contain poisonous or corrosive substances. If the content has been set free observe the danger notes on the cell. If necessary take the corresponding protective measures (protective goggles, protective gloves etc.).



Warning

The thermoblock can become very hot (150 °C). There is danger of burning when the thermoblock is heated up.

1	Switch off the thermoreactor and disconnect the power plug.
2	Allow the thermoreactor to cool down.
3	Unscrew the cover plate on top of the thermoblock.
4	Clean the cover plate, block surfaces and borings with a damp cloth.
5	Screw on the cover plate again.

6.5 Disposal

Dispose of the thermoreactor as electronic waste at an appropriate collection point. It is illegal to dispose of the thermoreactor in household refuse.

7 What to do if...

There is nothing on the display

Cause	Remedy
<ul style="list-style-type: none"> - The power supply is interrupted 	<ul style="list-style-type: none"> - Check mains cable and connections - Exchange the fuses - Repair by service department

Bars are displayed instead of the temperature (-°C)

Cause	Remedy
<ul style="list-style-type: none"> - In the program selection mode: internal temperature probe defective 	<ul style="list-style-type: none"> - Repair by service department

Cuvette emptied / thermoblock contaminated

Cause	Remedy
<ul style="list-style-type: none"> - e. g. leaking cuvette 	<ul style="list-style-type: none"> - see section 6.4

8 Technical Data

Reactor type	Dry temperature control device with safety cover
Cell shafts	12 cell shafts for reaction cells 16 ± 0.2 mm
Reaction time setting	20 min, 30 min, 60 min, 120 min (via fixed programs)
Temperature setting	100 °C, 120 °C, 148 °C, 150 °C via fixed programs
Controlling accuracy	± 1 °C ± 1 Digit
Temperature stability	± 0.5 K
Overtemperature protection	190 °C ± 5 °C
Heating time (with empty thermoblock) from 25 °C to	100 °C approx. 5 min 120 °C approx. 7 min 148 °C approx. 10 min
Temperature of the enclose at an environmental temperature of 25 °C	< 30 °C with a block temperature of 148 °C
Power supply	230 VAC 50 Hz ± 15 % 115 VAC 60 Hz ± 15 % Power consumption: 280 W Fuses 2 x 3.15 AT
Enclosure	PC ABS, recyclable, high temperature resistant
Protective class	I according to DIN VDE 0700 part 1/11.90
Insulation group	Insulation group: B according to DIN VDE 0110/11.72
Overvoltage category	II
Protection	IP 20 according to DIN 40050
Ambient temperature	Storage -25 °C to +65 °C Operation +5 °C to +40 °C

Climatic class	2 according to VDI/VDE 3540 Relative humidity: Yearly mean: < 75 % 30 days /year: 95 % Other days: 85 % Light dew: yes
EMC	EN61326 FCC Class A
Test certificates	cETLus, CE
Dimensions	D x W x H: 292 x 245 x 180 mm
Weight:	2,9 kg
Safety standards	EN61010 UL3101 CAN/CSA C22.2-1010 EN61010-2-010 IEC-CAN/CSA C22.2-1010.2.010

9 Index

A

Authorized use40

C

Commissioning43

Components of the thermoreactor38

Control lamps (LEDs)49

D

Display49

F

Fuses57

K

Keys48

M

Maintenance57

O

Operating and display elements47

Operating modes50

Operating safety40

P

Program selection50

S

Safety measures39

Scope of delivery43

Setting the display contrast54

Standby50

T

Temperature program

 starting51

 stopping53

Temperature program active50

Trouble shooting59

W

What to do if... 59



Wissenschaftlich-Technische Werkstätten GmbH

Dr.-Karl-Slevogt-Straße 1
D-82362 Weilheim

Germany

Tel: +49 (0) 881 183-0
+49 (0) 881 183-100
Fax: +49 (0) 881 183-420
E-Mail: Info@WTW.com
Internet: <http://www.WTW.com>